

### Features & Benefits

- Single Phase Universal AC input
- Rugged Unit for Military Applications
- High Efficiency, High Power Density
- Wide Input Voltage Range
- Built-in Active PFC Function
- Charger for Lead-Acid Batteries (Flooded, GEL and AGM) and Li-Ion Batteries (Lithium Iron and Lithium Manganese)
- Internal OR-ing Diode
- Multiple Units in a Redundant or Parallel System
- Droop Current Sharing
- IP67 Sealed
- RS485 Communication
- Temperature Sensor
- Power Good Signal
- Input Under Voltage Protection
- Input/Output Over Voltage Protection
- Input Over Current Protection
- Short Circuit Protection
- Over Temperature Protection
- Reverse Battery Protection
- Two unit can be mounted in 2U height 19" Rack
- On/Off Switch
- LED Indicators
- Grounding Interface

### Compliance

Module is designed to meet:

- MIL-STD-461G
- MIL-STD-810G
- MIL-STD-1275E

### Typical Applications

- Military/Defense Power Systems
- Armored Vehicles
- Land Platforms
- Communications and Radar Systems

Product Ratings	
$V_{IN}$	90–265 $V_{RMS}$ (single phase)
$V_{IN\_NOM}$	220 $V_{RMS}$
$V_{OUT}$	28 $V_{DC}$
$I_{OUT\_MAX}$	120 $A_{DC}$
$P_{OUT\_MAX}$	3360 W

### Product Description

KMBC11 is a high efficiency AC-DC battery charger unit. The unit regulates a constant current at the output. Charger unit is designed to guarantee high performance under extreme environmental conditions. It has superior protection features against external faults and disturbances while meeting the major military standards. KOLT's innovative engineering has enabled a compact design of the converter with high power density and performance.

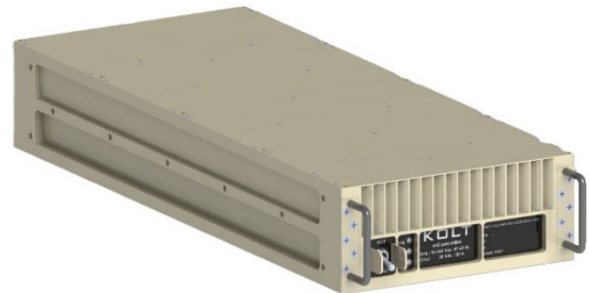

Size: 530.00 x 215.90 x 87.75 mm  
(19" / 2 form factor, 2U height)

Weight: 13 kg

## Electrical Characteristics

Input Characteristics					
Parameters	Notes & Conditions	Min	Typ	Max	Unit
Input Voltage		90	220	265	V <sub>RMS</sub>
Input Voltage (non-working)	Withstanding input voltage	-	-	300	V <sub>RMS</sub>
Input Frequency		47	50	63	Hz
Input Current THD	From half load to full load, nominal input voltage	-	-	10	%
No Load Input Power	Nominal input voltage	-	-	50	W
Inrush Current	Nominal input voltage	-	-	±40	A <sub>PK</sub>
Leakage Current to Ground	10% load, nominal input voltage	-	-	5	mA <sub>RMS</sub>
AC Input Quiescent Current	When input switch is OFF	-	-	200	mA <sub>RMS</sub>

Output Characteristics					
Parameters	Notes & Conditions	Min	Typ	Max	Unit
Output Voltage		-	28	-	V <sub>DC</sub>
Output Current		-	-	120	A <sub>DC</sub>
Output Power	Subject to derating per input voltage (see Figure 17)	-	-	3360	W
Output Ripple and Noise	20 MHz Bandwidth	-	-	0.4	V <sub>PK-PK</sub>
Line Regulation	Over the full range of line input voltage	-	±0.1	-	V <sub>DC</sub>
Load Regulation	From 10% load to full load, nominal input voltage	-	±0.1	-	V <sub>DC</sub>
Battery Output Leakage Current	When input switch is OFF	-	-	5	mA <sub>DC</sub>

General Characteristics					
Parameters	Notes & Conditions	Min	Typ	Max	Unit
Efficiency	From half load to full load, nominal input voltage	90	-	-	%
Power Factor	From half load to full load, nominal input voltage	0.99	-	-	-
Soft-Start Time		-	-	1	s
Hold-up Time		10	15	-	ms
Weight		-	-	13	kg
Cooling	Forced air by temperature-controlled fans				
Built-in Test Feature	DC OK, Remote Error Sensing				

Protections					
Parameters	Notes & Conditions	Min	Typ	Max	Unit
<b>Input Under Voltage Protection</b>	When the voltage returns within the normal limits, unit resumes operation automatically	80	85	90	V <sub>RMS</sub>
<b>Input Over Voltage Protection</b>		265	270	275	V <sub>RMS</sub>
<b>Output Over Current Protection</b>	Fully electronic against over-load	-	-	130	A <sub>DC</sub>
<b>Output Over Voltage Protection</b>	-	-	-	32.4	V <sub>DC</sub>
<b>Input Over Current Protection</b>	Auto-retry				
<b>Output Short Circuit Protection</b>	Fully electronic against over-load and continuous short-circuit conditions				
<b>Over Temperature Protection</b>	Automatically resumes operation when temperature decreases				
<b>Battery</b>	Prevention of battery discharge when charger is off				
	Reverse polarity protection				

Isolation Characteristics					
Parameters	Notes & Conditions	Min	Typ	Max	Unit
<b>Insulation Resistance</b>	Input to Case	-	>100	-	MΩ
	Output to Case	-	>100	-	MΩ
<b>Isolation Voltage</b>	Input to Output	-	-	500	V
	Input to Case	-	-	500	V
	Output to Case	-	-	500	V

Environmental Characteristics						
Parameters	Standard	Min	Typ	Max	Unit	Status
Operational Temperature	MIL-STD-810G_CHG-1 Method 501.6/502.6 Procedure II	-32	-	+50	°C	Passed
Storage / Transport Temperature	MIL-STD-810G_CHG-1 Method 501.6/502.6 Procedure I	-40	-	+63	°C	Passed
Operational Low Pressure	MIL-STD-810G_CHG-1 Method 500.6 Procedure II	-	-	3000	m	Similarity*
Storage / Transport Low Pressure	MIL-STD-810G_CHG-1 Method 500.6 Procedure I	-	-	4500	m	Designed to Meet
Parameters	Standard	Waveform	Peak Value	Pulse Duration	Axis	Status
Shock	MIL-STD-810G_CHG-1 Method 516.7 Procedure I	Sawtooth	20g	11 ms	±X, ±Y, ±Z	Similarity*
		Half-Sine	10g	11 ms	±X, ±Y, ±Z	Similarity*
Parameters	Standard	Category	Figure	Platform	Vehicle	Status
Vibration	MIL-STD-810G_CHG-1 Method 514.7 Procedure I	Category 4	514.7C-2	Secured Cargo	Truck Transportation and Composite Wheeled Vehicles	Similarity*
		Category 8	514.7C-8	Aircraft	Propeller	Similarity*
		Category 11	514.7C-11	Railroad	Train	Similarity*
		Category 20	514.7C-4	Ground	Wheeled Vehicles	Similarity*
		Category 21	514.7D-9	Watercraft	Marine Vehicles	Similarity*
Parameters	Standard	Condition				Status
Salt Fog	MIL-STD-810G_CHG-1 Method 509.6	24 hours spray, 24 hours dry, applied 2 times				Designed to Meet
Sand and Dust	MIL-STD-810G_CHG-1 Method 510.6 Procedure I/II	<150 µm Dust 150-850 µm Sand				Similarity*
Fungus	MIL-STD-810G_CHG-1 Method 508.7	Analysis of the degree of inertness to fungus growth of the components.				Analysis
Solar Radiation	MIL-STD-810G_CHG-1 Method 505.6 Procedure I	A2				Designed to Meet
Humidity	MIL-STD-810G_CHG-1 Method 507.6 Procedure II	≥ %95 Relative @30°C				Similarity*
Impermeability	IP67	Tested by immersion in 1 m water for 30 minutes				Passed
Parameters	Standard	Test				Status
EMI/EMC	MIL-STD-461G Ground Army	CE102	CS101 CS114 CS115 CS116 CS118	RE102	RS103	Similarity*

\* Verified on similar unit. Both units consist of identical converter modules.

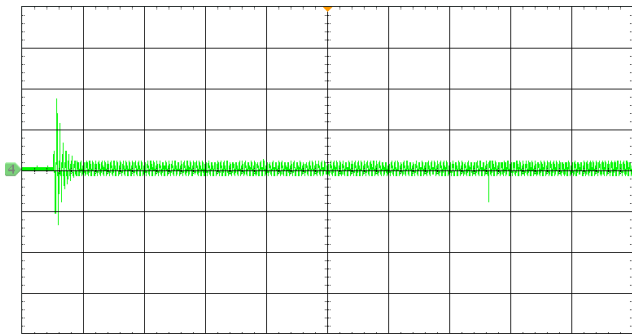

Input current (green) (10 A/div) Time base : 400 ms/div

**Figure 1.** Inrush current at nominal input voltage

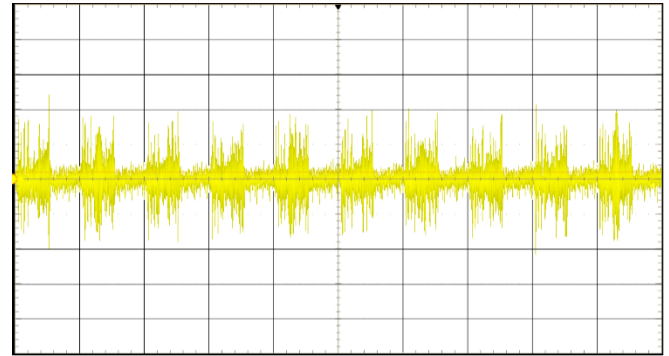

Leakage current (yellow) (10 mA/div) Time base : 20 ms/div

**Figure 4.** Leakage current to ground at nominal input voltage and 10% load current

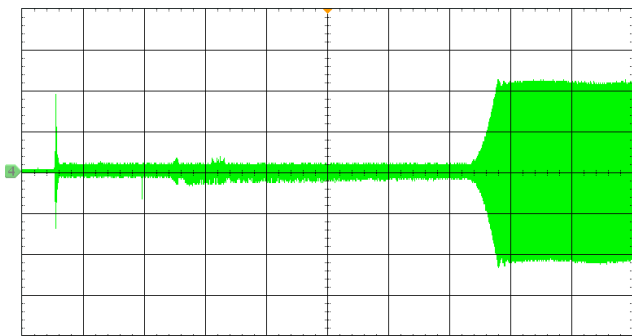

Input current (green) (10 A/div) Time base : 2 s/div

**Figure 2.** Input current for inrush and start-up stages at nominal input voltage

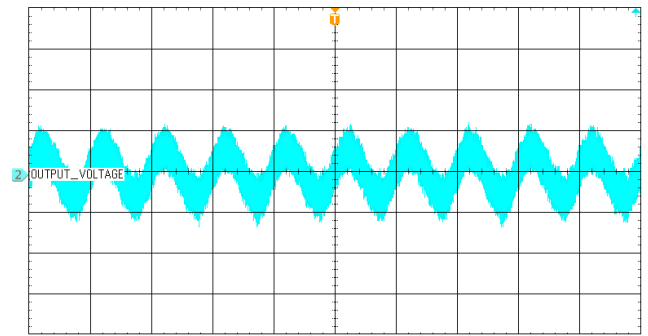

Output voltage (blue) (200 mV/div) Time base : 10 ms/div

**Figure 5.** Output voltage ripple at nominal input voltage and rated load current (AC Coupled), Bandwidth: 20 MHz

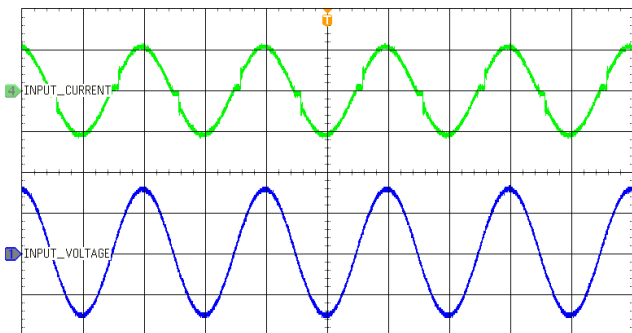

Input voltage (navy blue) (200 V/div) Time base : 10 ms/div  
Input current (green) (20 A/div)

**Figure 3.** Typical input voltage and current waveforms at rated load current

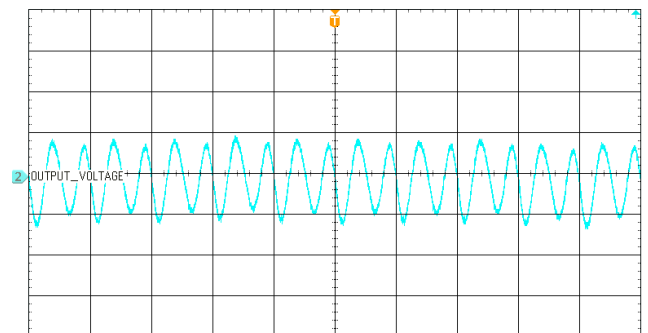

Output voltage (blue) (100 mV/div) Time base : 10 μs/div

**Figure 6.** Output voltage ripple at nominal input voltage and rated load current (AC Coupled), Bandwidth: 20 MHz

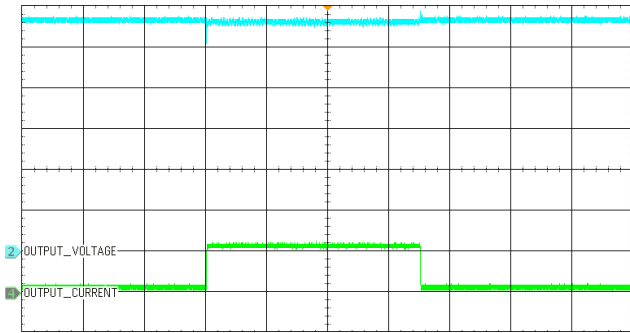

Output voltage (blue) (5 V/div)      Time base : 200 ms/div  
Output current (green) (100 A/div)

**Figure 7.** Load transient response: from 10% to 100% and from 100% to 10% at nominal output voltage (DC Coupled)

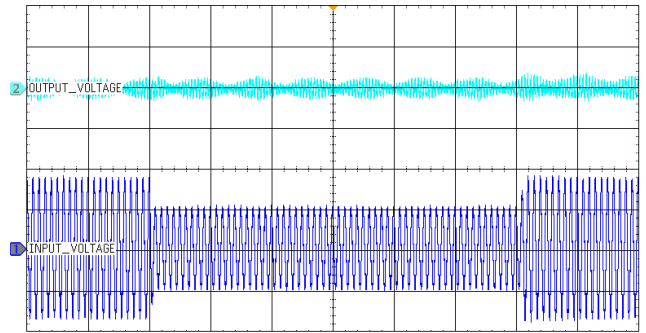

Output voltage (blue) (1 V/div)      Time base : 200 ms/div  
Input voltage (navy blue) (200 V/div)

**Figure 10.** Line transient response: from 265 V<sub>RMS</sub> to 135 V<sub>RMS</sub> and from 135 V<sub>RMS</sub> to 265 V<sub>RMS</sub> at nominal output voltage (AC Coupled)

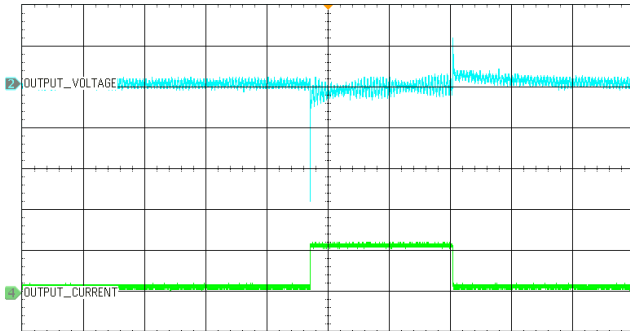

Output voltage (blue) (1 V/div)      Time base : 100 ms/div  
Output current (green) (100 A/div)

**Figure 8.** Load transient response: from 10% to 100% and from 100% to 10% at nominal output voltage (AC Coupled)

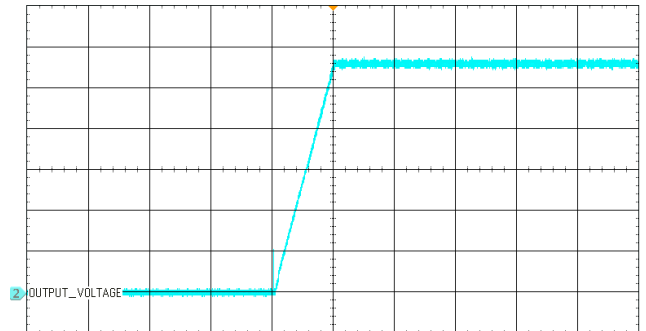

Output voltage (blue) (5 V/div)      Time base : 1 s/div

**Figure 11.** Start-up waveform at rated load current and nominal output voltage

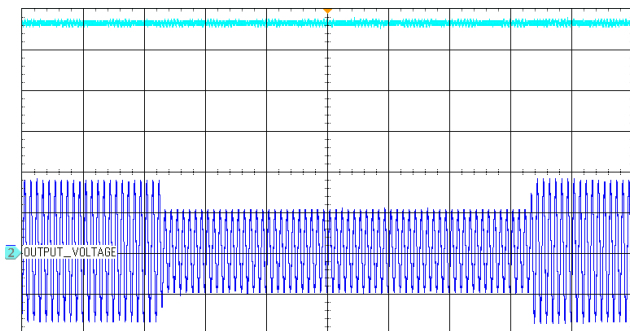

Output voltage (blue) (5 V/div)      Time base : 200 ms/div  
Input voltage (navy blue) (200 V/div)

**Figure 9.** Line transient response: from 265 V<sub>RMS</sub> to 135 V<sub>RMS</sub> and from 135 V<sub>RMS</sub> to 265 V<sub>RMS</sub> at nominal output voltage (DC Coupled)

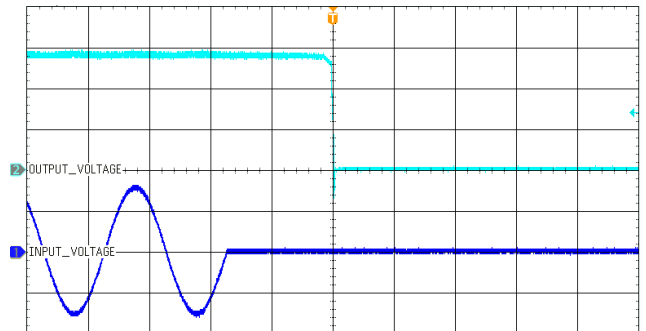

Output voltage (blue) (10 V/div)      Time base : 10 ms/div  
Input voltage (navy blue) (200 V/div)

**Figure 12.** Hold-up waveform at rated load current and nominal output voltage

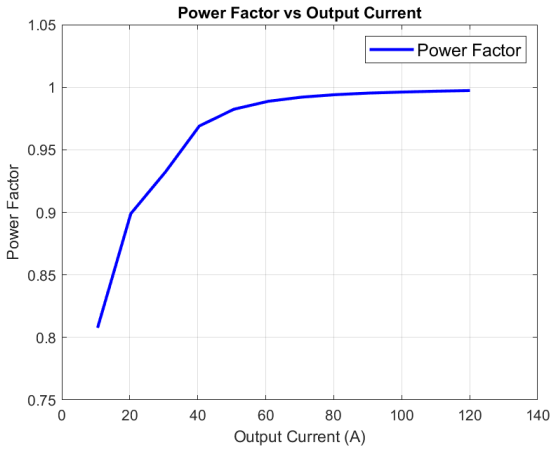

**Figure 13.** Power factor versus output current at nominal input voltage

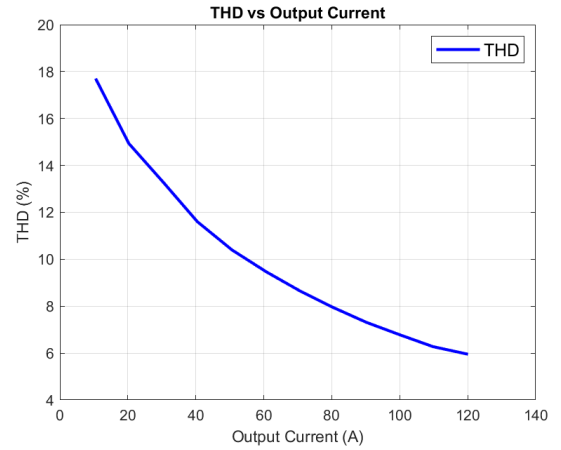

**Figure 16.** Total harmonic distortion (THD) versus output current at nominal input voltage

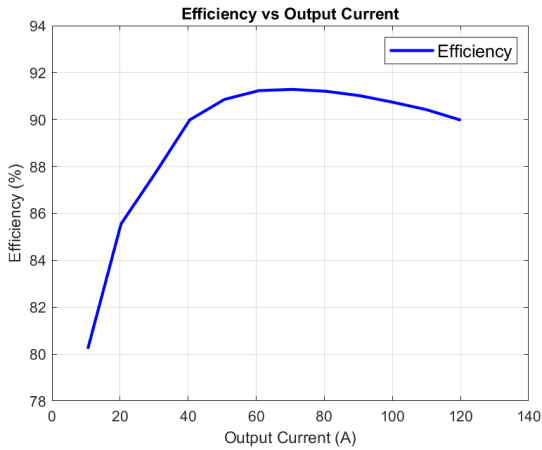

**Figure 14.** Efficiency versus output current at nominal input voltage

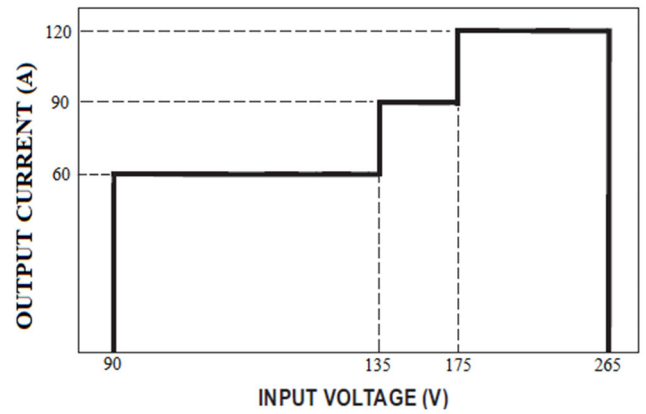

**Figure 17.** Derating curve of output load versus input voltage

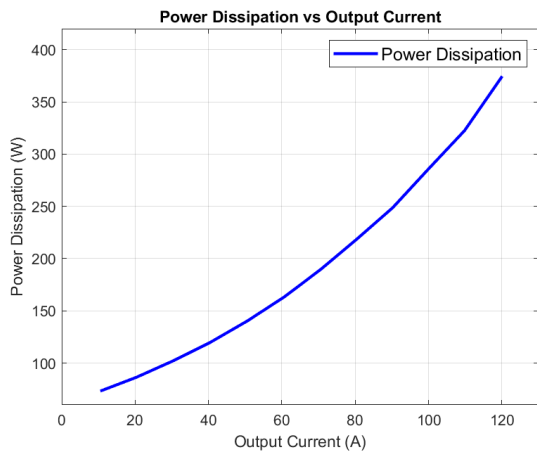

**Figure 15.** Power dissipation versus output current at nominal input voltage

## Connector Configuration

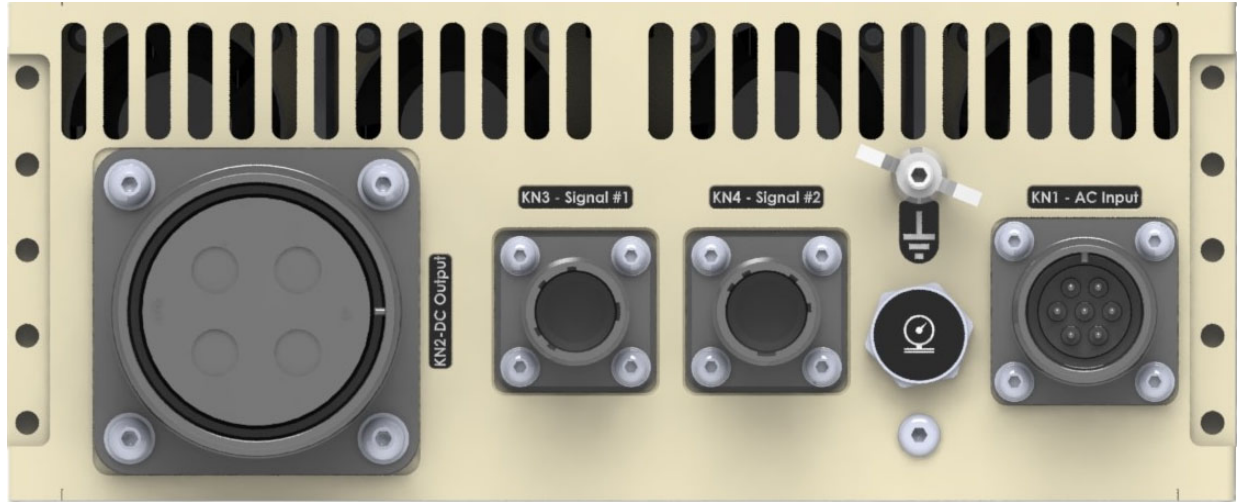

Figure 18. Connector Panel

## AC Input Connector (KN1)

### Part Numbers (interchangeable):

- Amphenol 97B-4102E-16S-1P
- ITT Cannon CA3102E16S-1P-B-F80

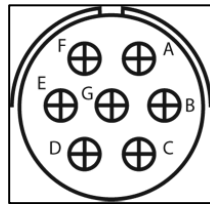

Figure 19. Input Connector View

Pin	Signal Name	Function
A	PHASE	AC Line Input (PHASE)
B	PHASE	AC Line Input (PHASE)
C	PHASE	AC Line Input (PHASE)
D	NEUTRAL	AC Line Input (NEUTRAL)
E	NEUTRAL	AC Line Input (NEUTRAL)
F	NEUTRAL	AC Line Input (NEUTRAL)
G	CHASSIS	AC Line Input (EARTH)



## DC Output Connector (KN2)

### Part Numbers (interchangeable):

- Amphenol 97B-4102E-32-17S
- ITT Cannon CA3102E32-17S-B-F80

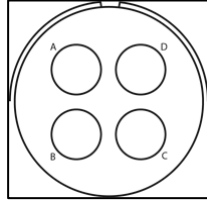

Figure 20. Output Connector View

Pin	Signal Name	Function
A	OUT	DC Output
B	OUT	DC Output
C	OUT_RTN	DC Output Return
D	OUT_RTN	DC Output Return

## Signal Connector #1 (KN3)

### Part Numbers:

- D38999/20WB35SN

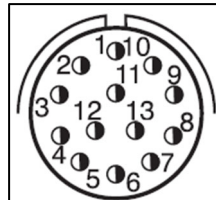

Figure 21. Signal Connector View

Pin	Signal Name	Function
1	DATA+	Factory service input.
2	DATA-	Factory service input.
3	DATA_RTN	Factory service return signal.
4	-	-
5	ID0	Identification input.
6	ID1	Identification input.
7	ID2	Identification input.
8	ID3	Identification input.
9	ID_RTN	Identification return signal.
10	-	-
11	CS_DATA+	Current share input.
12	CS_DATA-	Current share input.
13	CS_DATA_RTN	Current share return signal.

## Signal Connector #2 (KN4)

### Part Numbers:

- D38999/20WB35SA

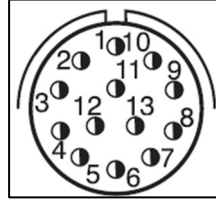

Figure 22. Signal Connector View

Pin	Signal Name	Function
1	DATA+	Factory service input.
2	DATA-	Factory service input.
3	DATA_RTN	Factory service return signal.
4	-	-
5	NTC	Temperature sensor.
6	NTC_RTN	Temperature sensor return signal.
7	PGOOD	Power good signal.
8	PGOOD_RTN	Power good return signal.
9	-	-
10	-	-
11	CS_DATA+	Current share input.
12	CS_DATA-	Current share input.
13	CS_DATA_RTN	Current share return signal.

## LED Configuration

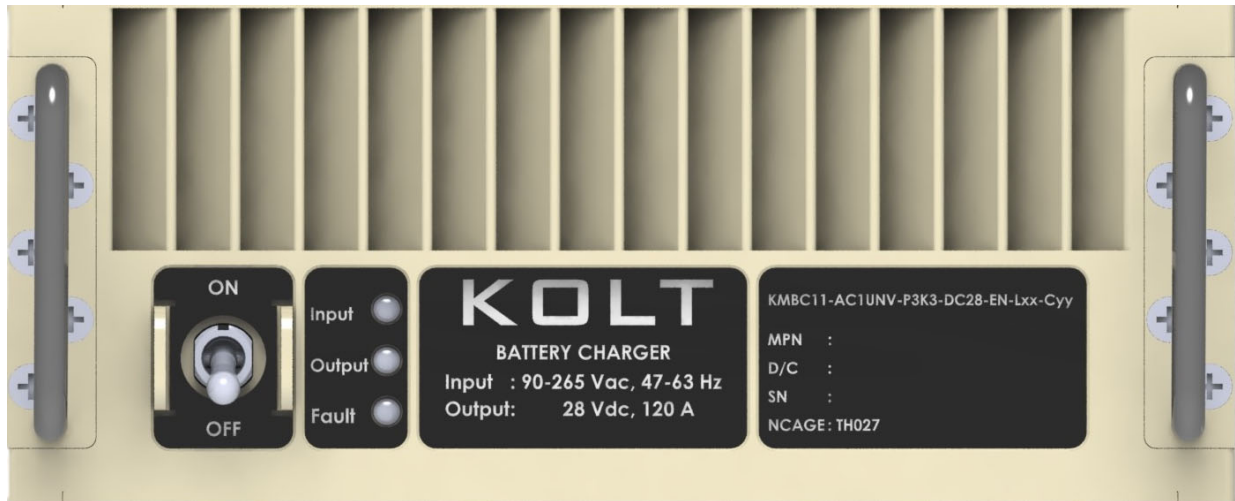

Figure 23. Front Panel

LED Name	Status	Description	Function
Input	Off	AC Input Passive	AC input is below 70 Vac
	Green	AC Input Active	AC input voltage is within the operating limit (90-265 Vac)
	Red	AC Input Fault	<ul style="list-style-type: none"> <li>Input Under Voltage / Over Voltage</li> <li>Input Over Current</li> <li>Line Frequency not within limits</li> </ul>

LED Name	Status	Description	Function
Output	Off	DC Output Passive	DC output is not active
	Green	DC Output Active	DC output is within the defined limits
	Red	DC Output Fault	<ul style="list-style-type: none"> <li>Output Over Voltage / Short Circuit</li> <li>Output Reverse Voltage</li> <li>Output Regulation Error</li> </ul>

LED Name	Status	Description	Function
Fault	Off	Device OK	No fault is present
	Red	Device Fault	<ul style="list-style-type: none"> <li>Mid-Bus Over Voltage</li> <li>Temperature</li> <li>Critical Fault</li> </ul>

## Color Configuration

Color Option	Standard	Color Code	Color Name
C01	RAL	6014	Yellow Olive
C02	RAL	9005	Jet Black
C03	FED-STD-595C	34094	Green 383 Camouflage
C04	FED-STD-595C	37030	Black Camouflage
C05	RAL	9016	Traffic White
C06	RAL	7001	Silver Grey
C07	FED-STD-595C	30315	Desert Sand Camouflage
C08	FED-STD-595C	33245	Earth Yellow Camouflage

## Label Configuration

Label Option	Description
L01	Label for Turkish language
L02	Label for English language



Figure 24. L01 Label Option Front View



Figure 25. L01 Label Option Back View

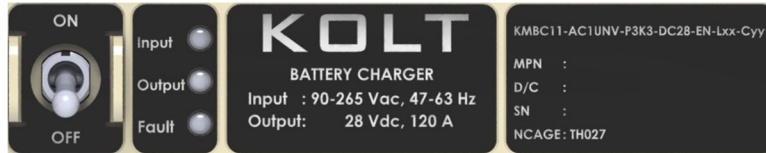

Figure 26. L02 Label Option Front View



Figure 27. L02 Label Option Back View

## Mechanical Drawings

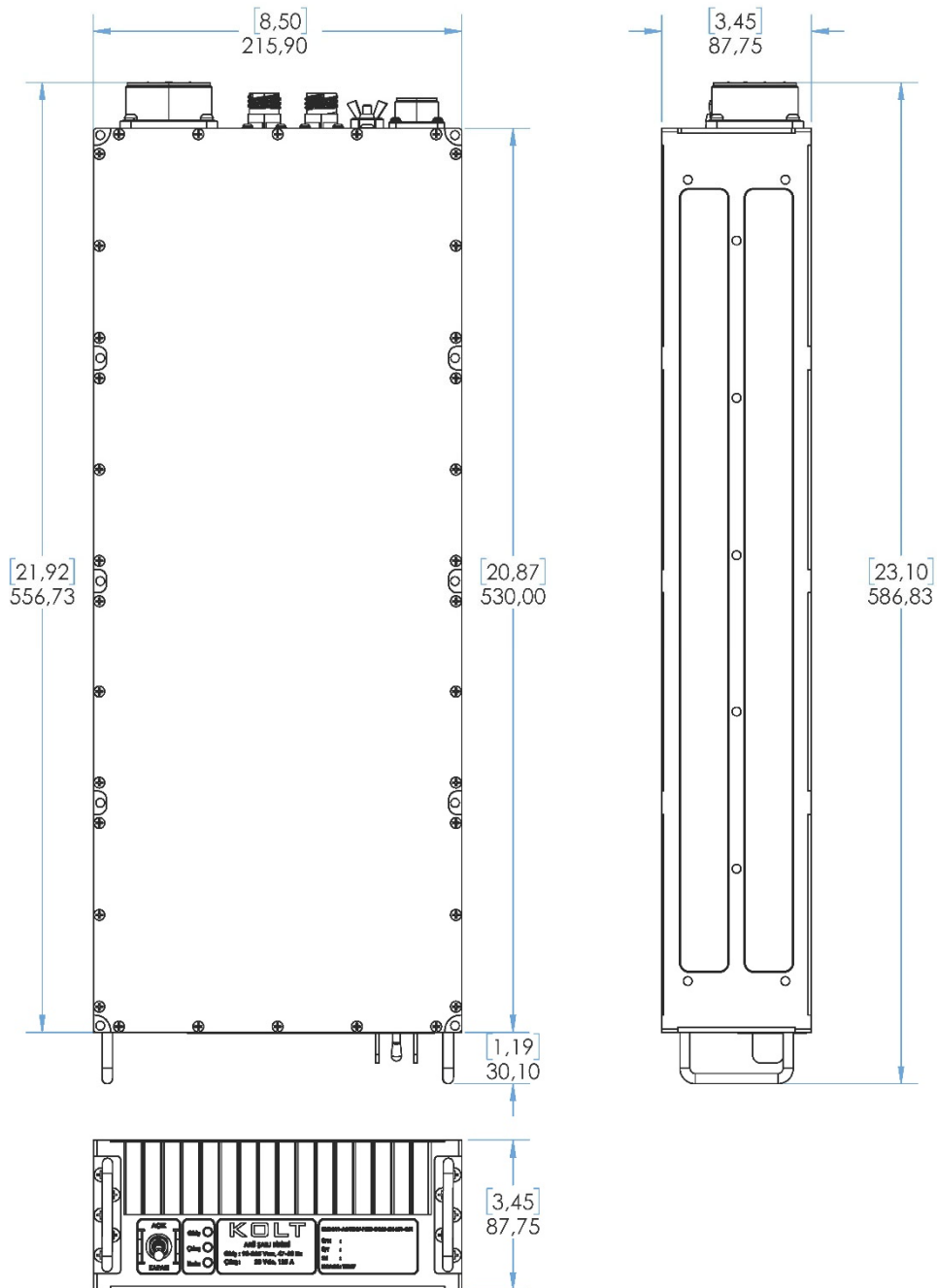

Figure 28. Mechanical Dimensions

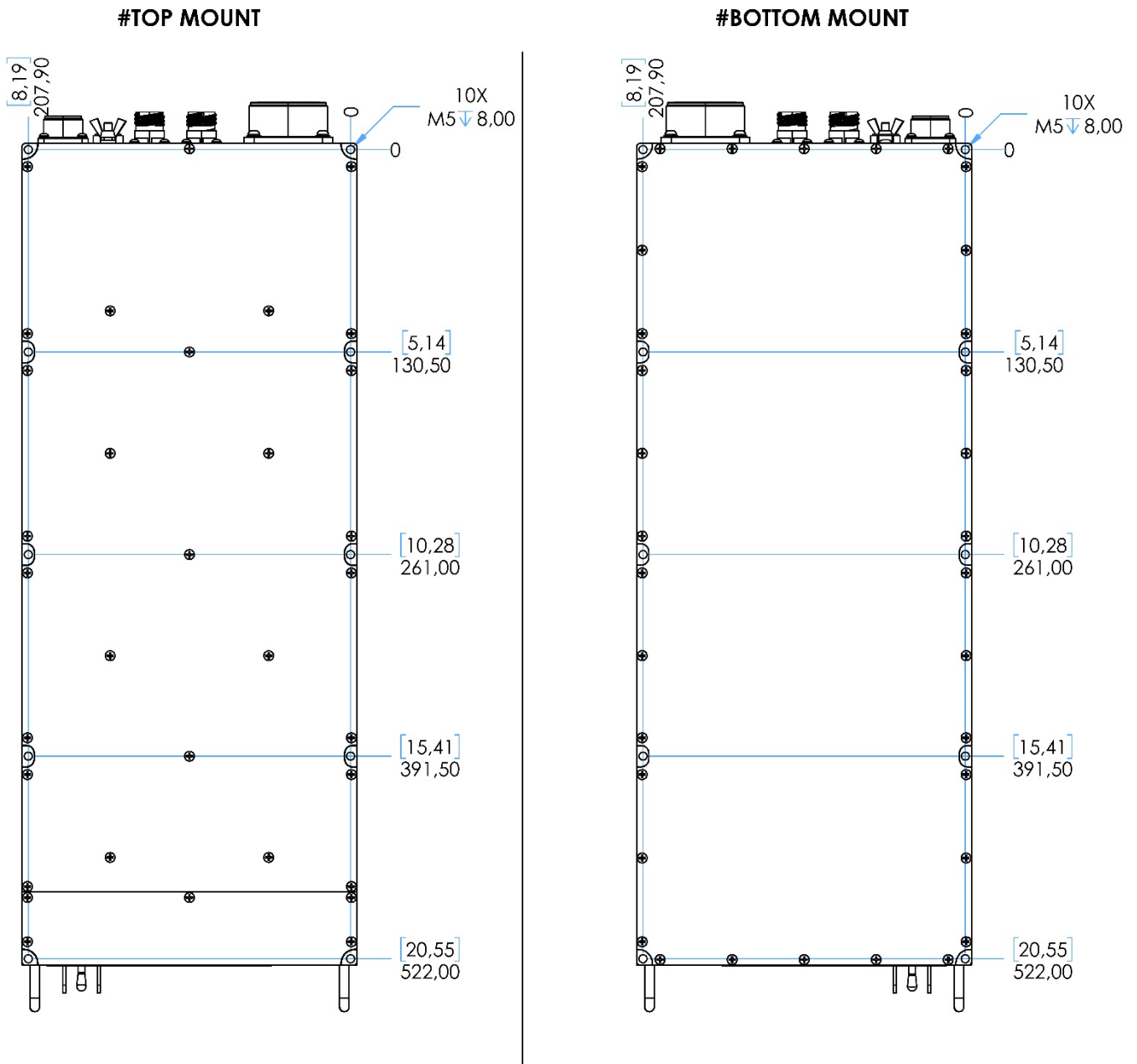

Figure 29. Mounting Details and Mounting Holes Coordinates

**Material:** Aluminum Alloy 6061-T6

Dimensions are in millimeters [inches].

### Part Ordering Information

Family	Input Voltage	Output Power	Output Voltage	Package	Color	Label	Option Field
KMBC11	AC1UNV Single Phase Universal AC	P3K3 3.3 kW	DC28 28 VDC	EN Enclosed	Cxx (C01-C99)	Lxx (L01-L99)	-

Ordering Number	Color Option	Label Option
KMBC11-AC1UNV-P3K3-DC28-EN-C01-L01	RAL 6014 Yellow Olive	Turkish
KMBC11-AC1UNV-P3K3-DC28-EN-C02-L01	RAL 9005 Jet Black	Turkish
KMBC11-AC1UNV-P3K3-DC28-EN-C03-L01	FED-STD-595C 34094 Green 383 Camouflage	Turkish
KMBC11-AC1UNV-P3K3-DC28-EN-C04-L01	FED-STD-595C 37030 Black Camouflage	Turkish
KMBC11-AC1UNV-P3K3-DC28-EN-C05-L01	RAL 9016 Traffic White	Turkish
KMBC11-AC1UNV-P3K3-DC28-EN-C06-L01	RAL 7001 Silver Grey	Turkish
KMBC11-AC1UNV-P3K3-DC28-EN-C07-L01	FED-STD-595C 30315 Desert Sand Camouflage	Turkish
KMBC11-AC1UNV-P3K3-DC28-EN-C08-L01	FED-STD-595C 33245 Earth Yellow Camouflage	Turkish
KMBC11-AC1UNV-P3K3-DC28-EN-C01-L02	RAL 6014 Yellow Olive	English
KMBC11-AC1UNV-P3K3-DC28-EN-C02-L02	RAL 9005 Jet Black	English
KMBC11-AC1UNV-P3K3-DC28-EN-C03-L02	FED-STD-595C 34094 Green 383 Camouflage	English
KMBC11-AC1UNV-P3K3-DC28-EN-C04-L02	FED-STD-595C 37030 Black Camouflage	English
KMBC11-AC1UNV-P3K3-DC28-EN-C05-L02	RAL 9016 Traffic White	English
KMBC11-AC1UNV-P3K3-DC28-EN-C06-L02	RAL 7001 Silver Grey	English
KMBC11-AC1UNV-P3K3-DC28-EN-C07-L02	FED-STD-595C 30315 Desert Sand Camouflage	English
KMBC11-AC1UNV-P3K3-DC28-EN-C08-L02	FED-STD-595C 33245 Earth Yellow Camouflage	English

## Revision History

Revision	Date	Description	Page Number(s)
A-PC1	01.01.2024	Initial Release	-
A-PC2	19.01.2024	Features & Benefits updated.	1